



Dimension Alley



3D PRINTING

Why customers choose 3D printing?

Cheaper

Start-ups

Small series

Established designers

Logical next step

Architects

Dentists

Jewelers

Artists (Digital)

Best method for manu

Jewelers

Unique

Express customer

Hype based

Fashion

Innovation

Because it's cool



Automated file upload

Upload to Print

HOME > Upload to Print

The price is a guide only. We will contact you with the details of your offer.

When you click "Request to print" you may add any additional information or requirements into the message box.

We have an extensive range of colours, so if you don't find one you like from the colour selector, let us know your desired colour.

Volume: 21.039777962364 cubic cm



Colour

| | | | | |
|--------------------------|--------------------------|--------------------------|--------------------------|--------------------------|
| <input type="checkbox"/> | <input type="checkbox"/> | <input type="checkbox"/> | <input type="checkbox"/> | <input type="checkbox"/> |
| <input type="checkbox"/> | <input type="checkbox"/> | <input type="checkbox"/> | <input type="checkbox"/> | <input type="checkbox"/> |

Material

| | | |
|---|--------------------------------------|-------------------------------------|
| <input checked="" type="button" value="Pla"/> | <input type="button" value="Flexi"/> | <input type="button" value="Wood"/> |
| <input type="button" value="Stone"/> | <input type="button" value="Bend"/> | <input type="button" value="Glow"/> |

Scale:

%

X X cm

Price: (EUR)€ 21.04

Powered by 



Dimension Alley



Your product design and development lab

myProductLab

By DimensionAlley

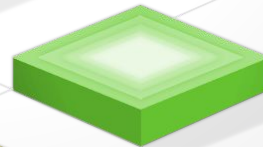
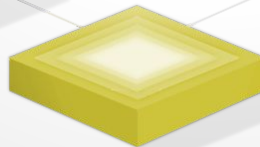
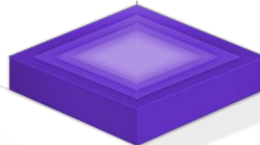
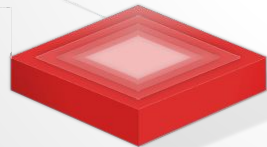
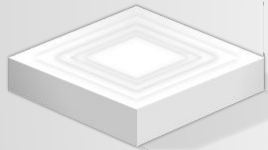



Ideation and design

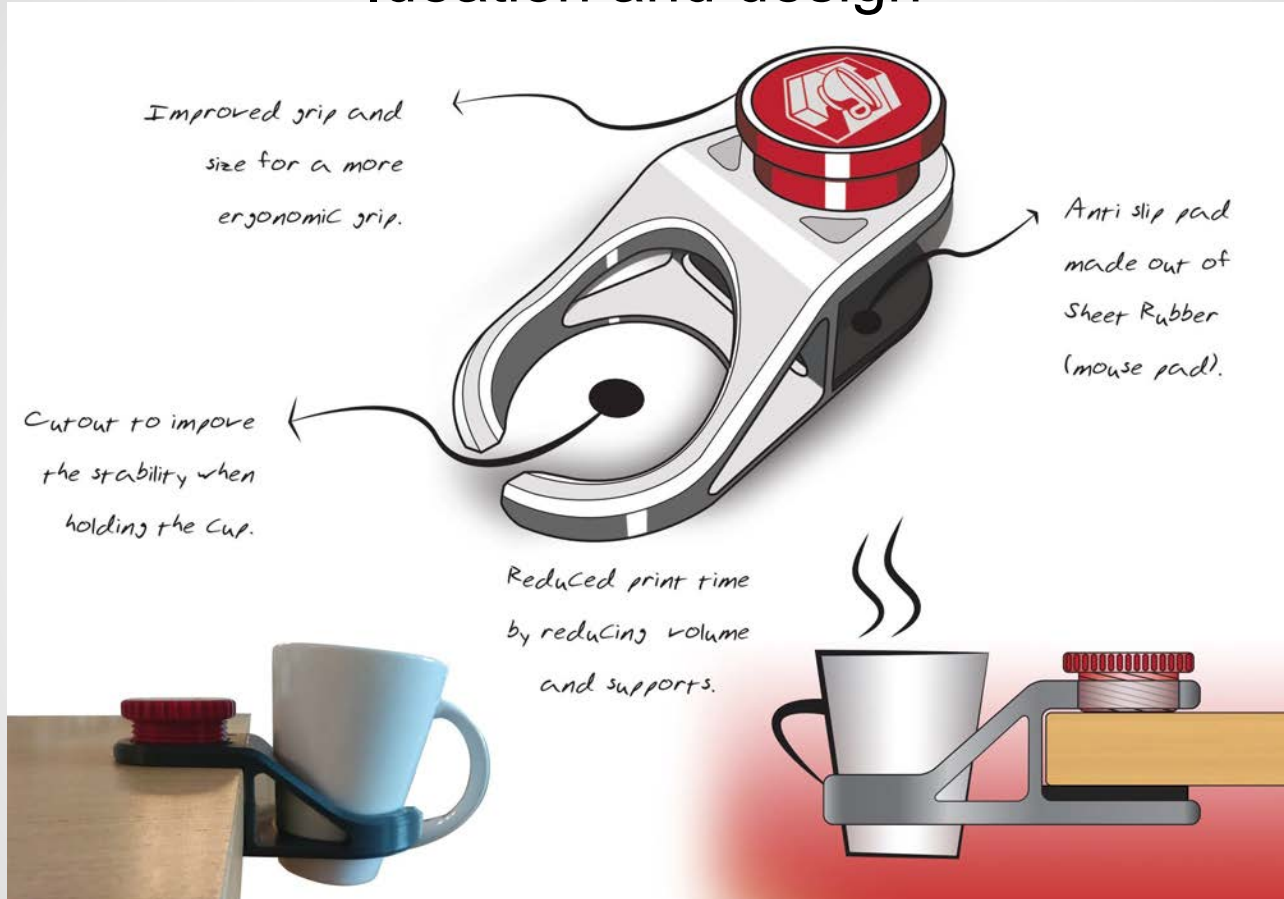



Rapid Prototyping





Dimension Alley

3D Print to go





Functional Prototypes





Large volume 3D printers

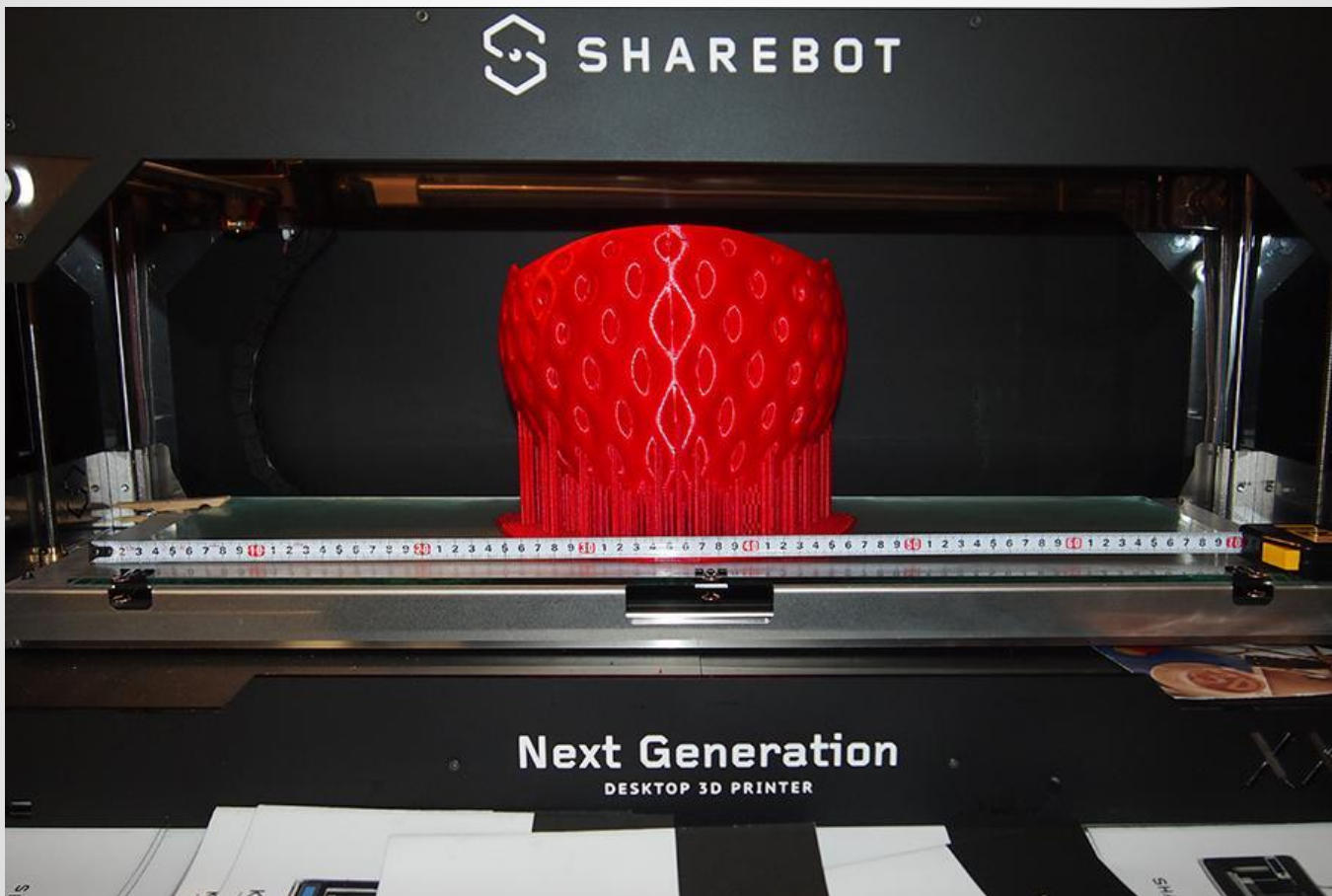



Form - Fit Prototypes

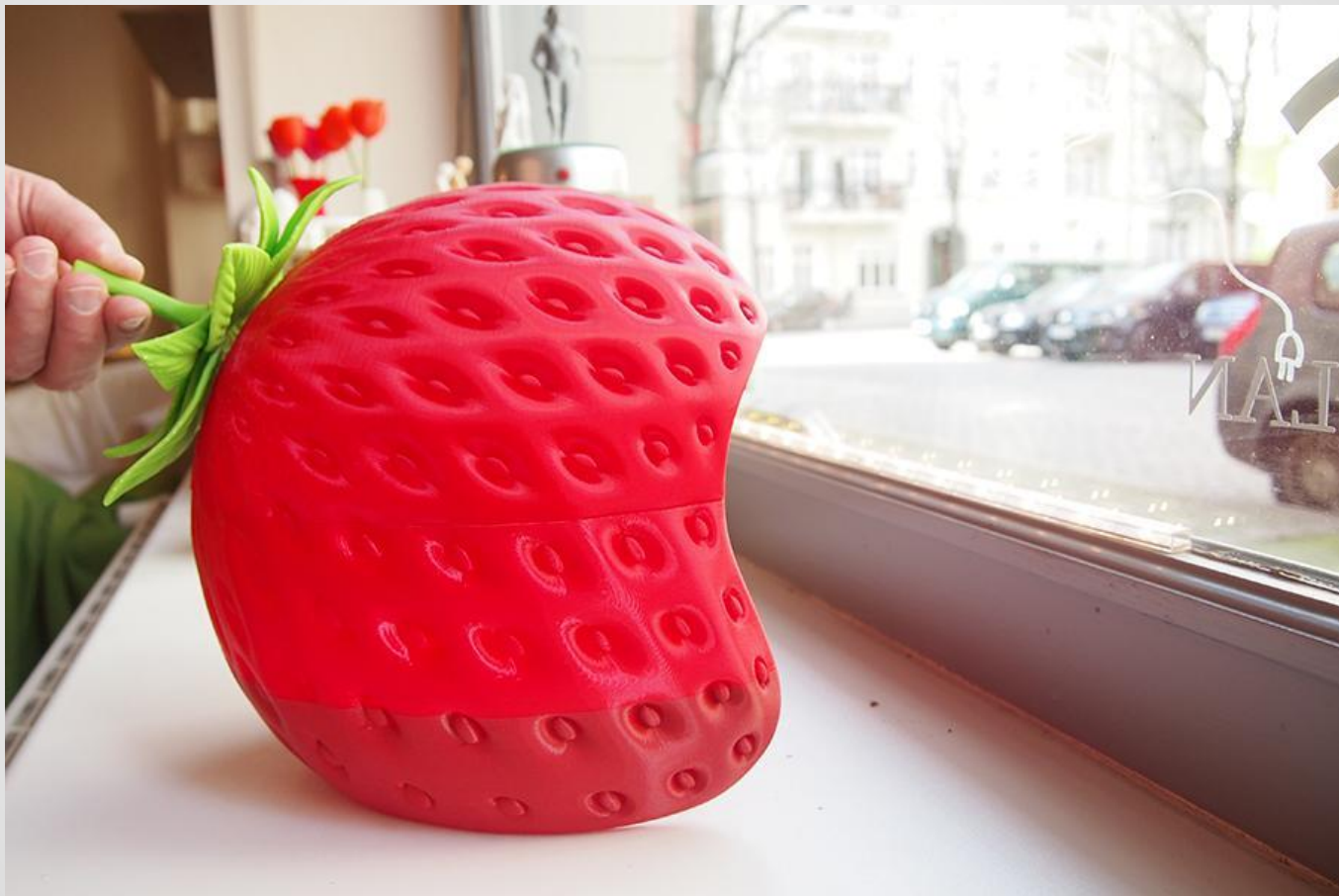



Dimension Alley

Unique products

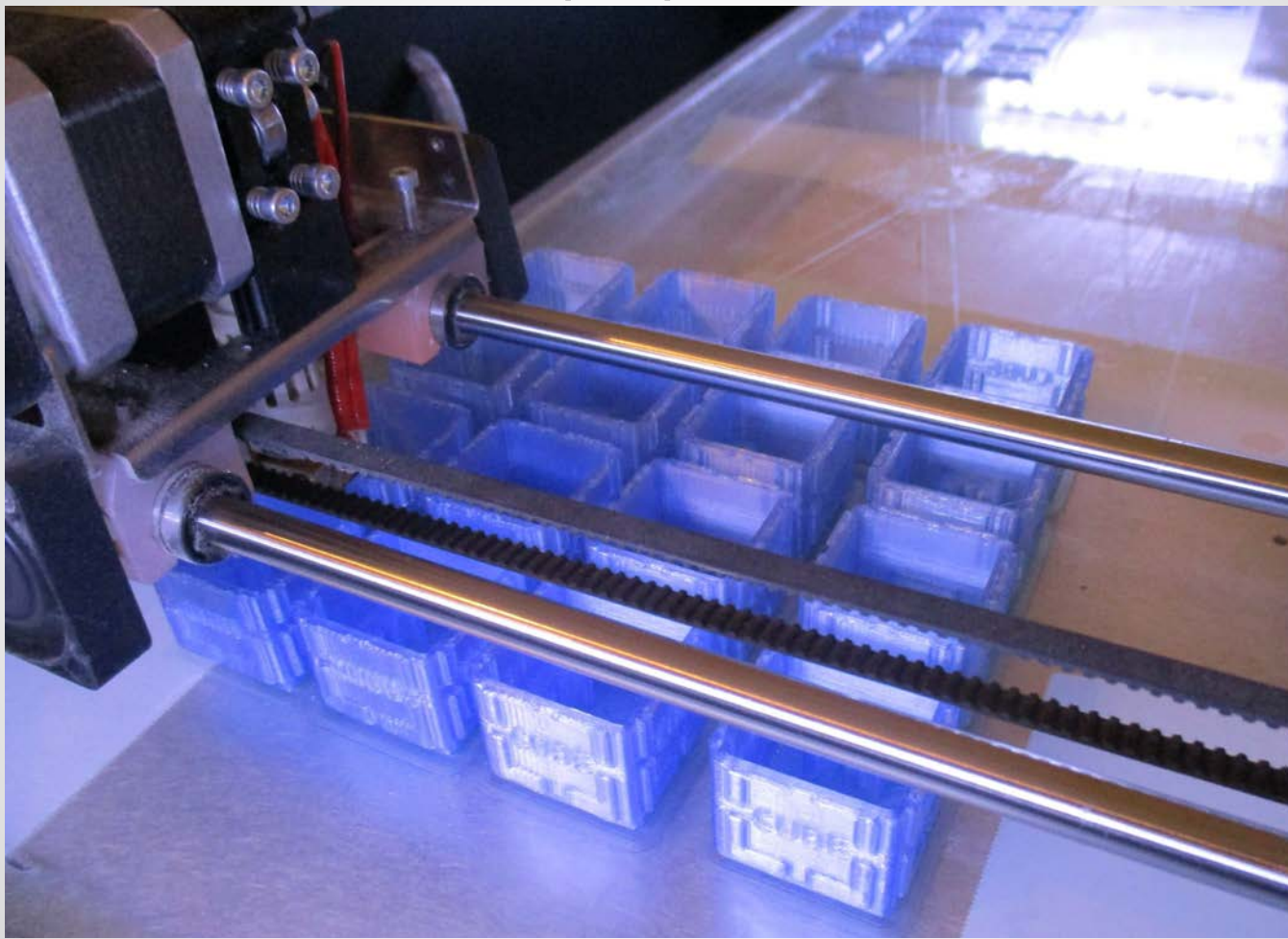



Sketch to CAD model

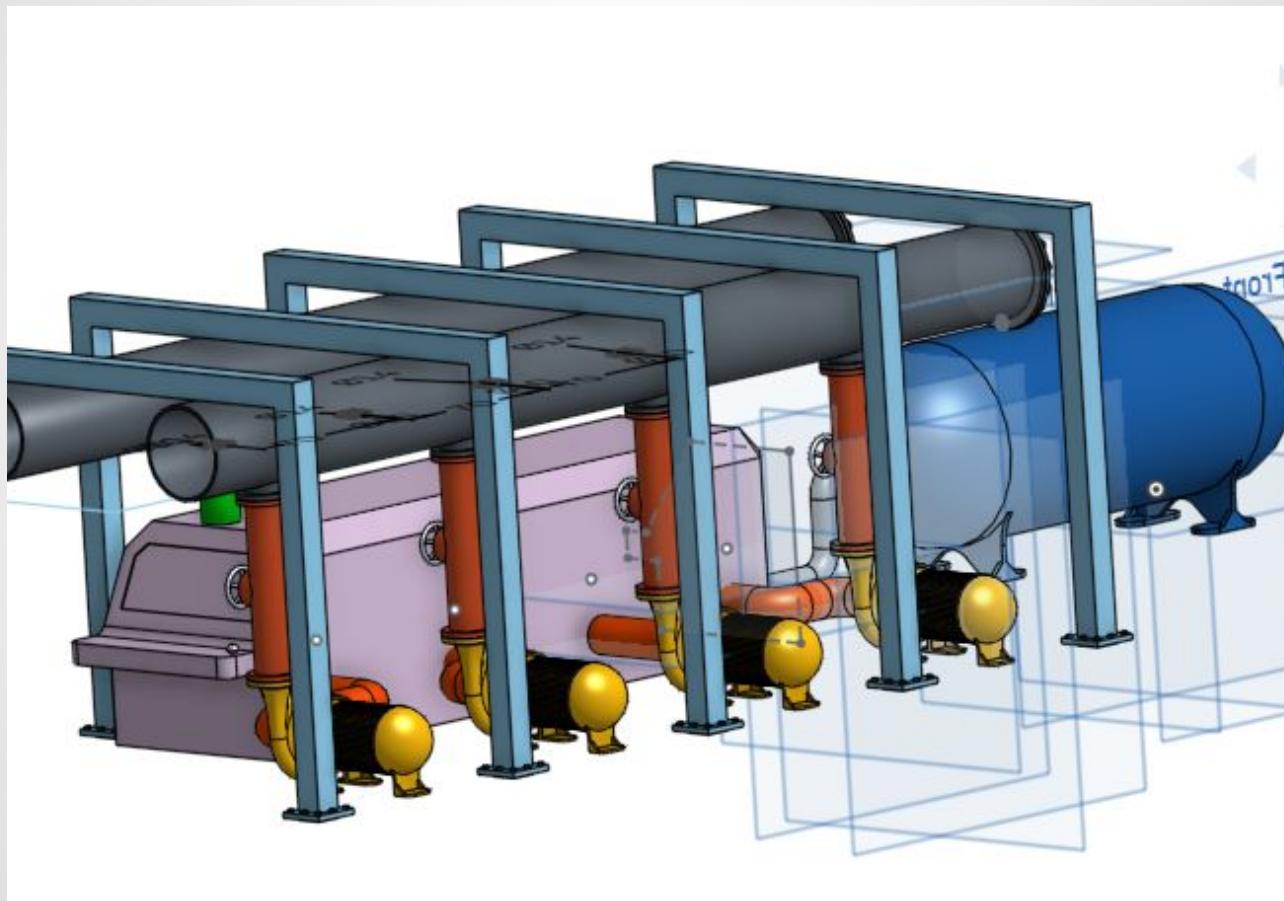



Visualisation Models

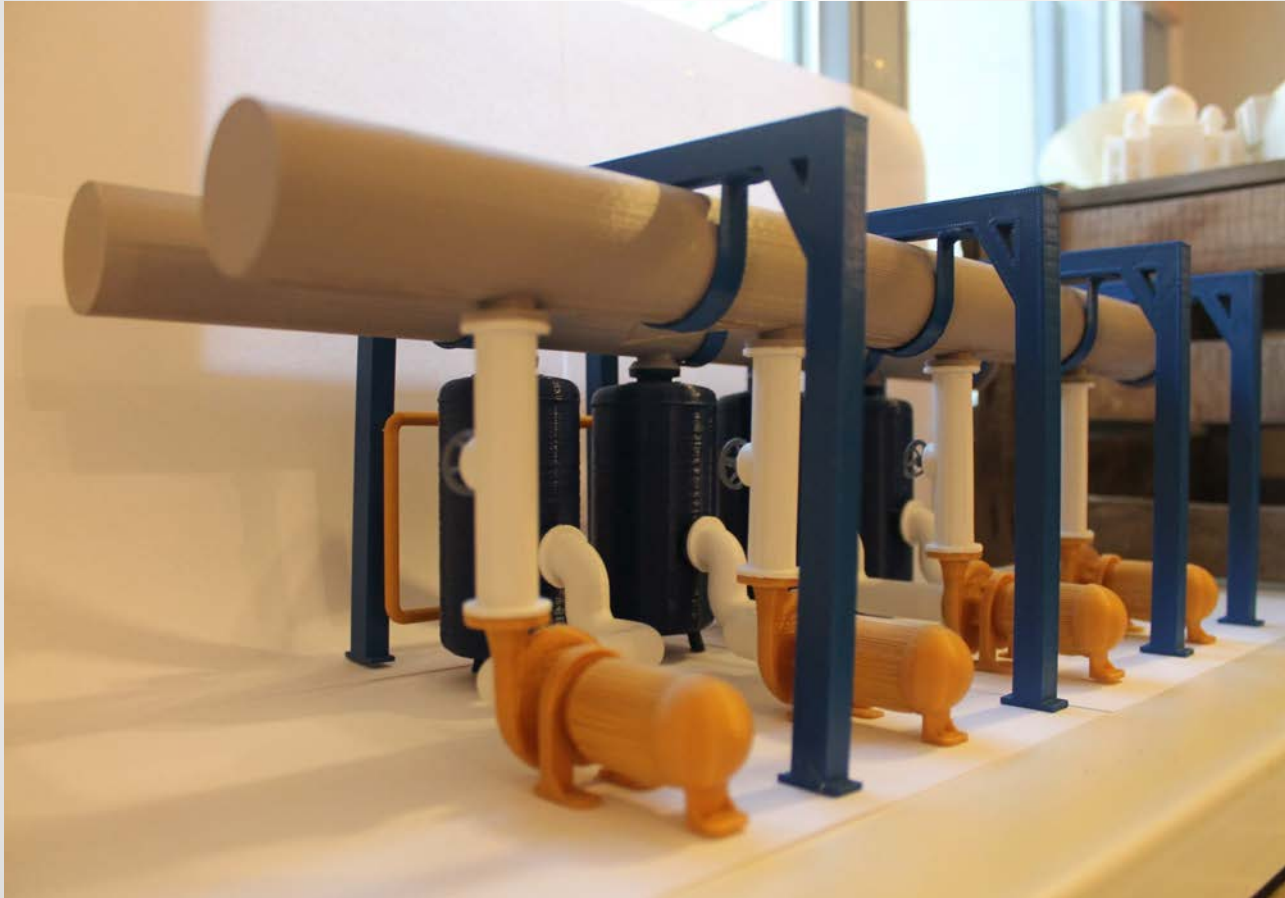



Final Unique Products



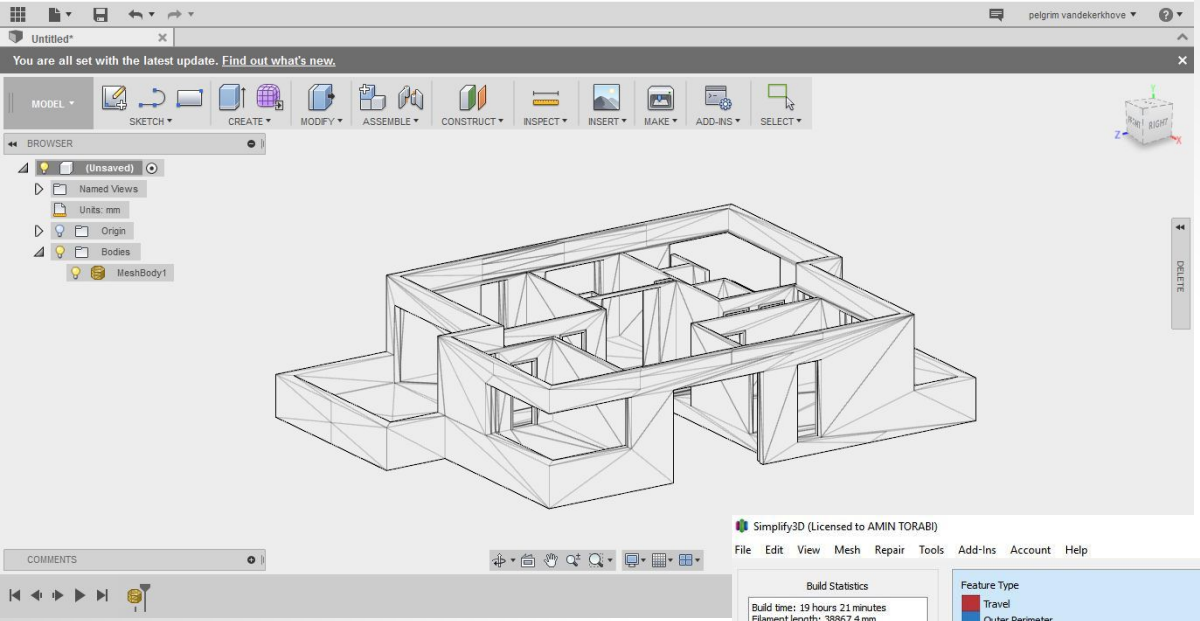

Architecture

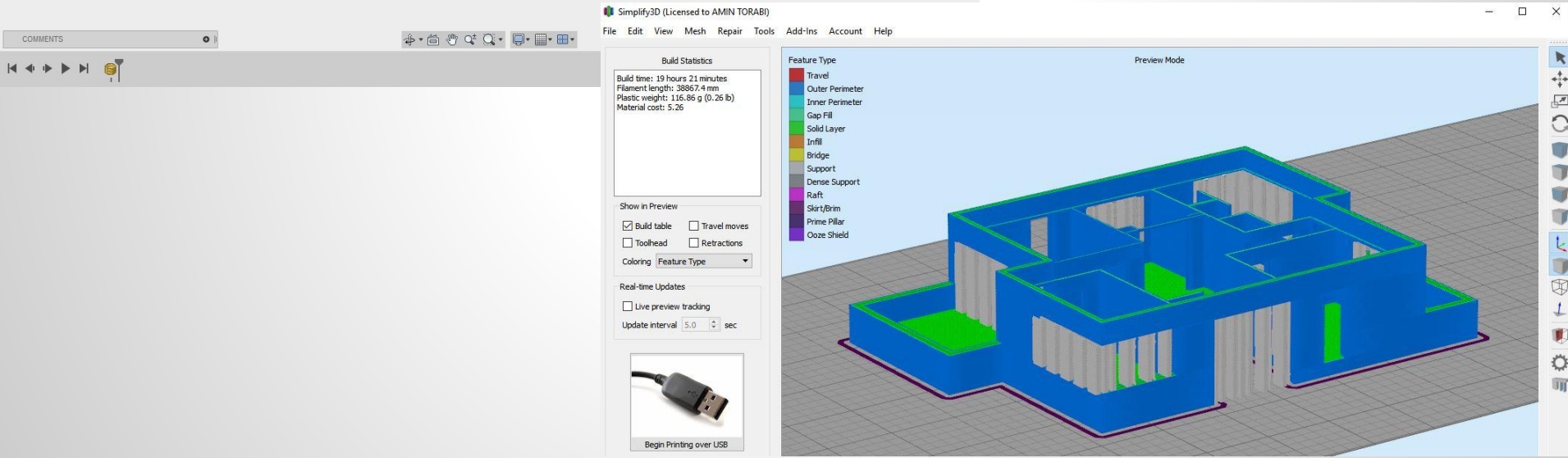



Dimension Alley

Architectural Models





Hand Finishing



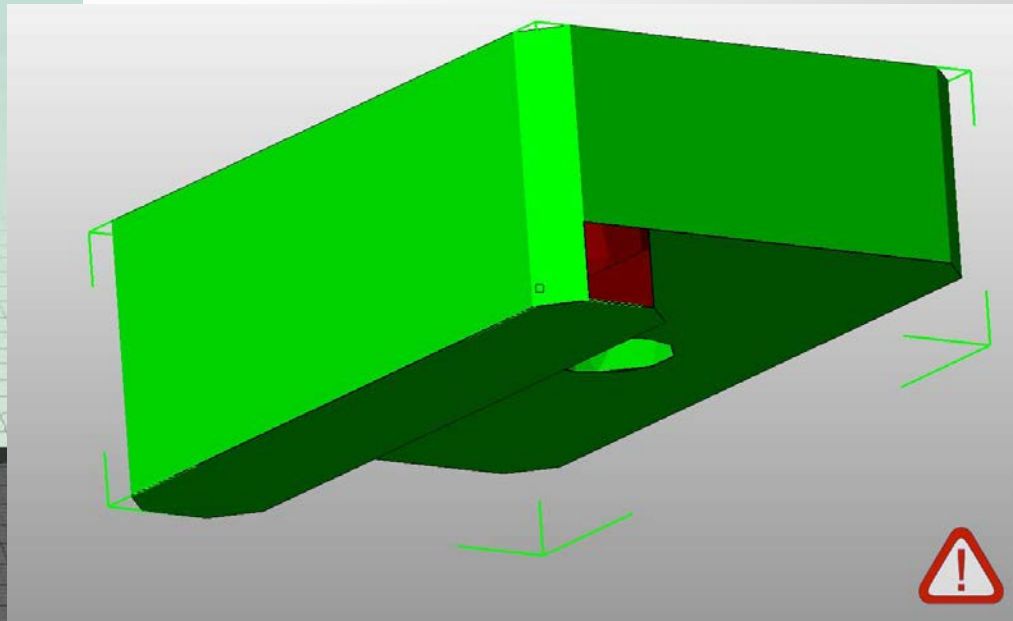
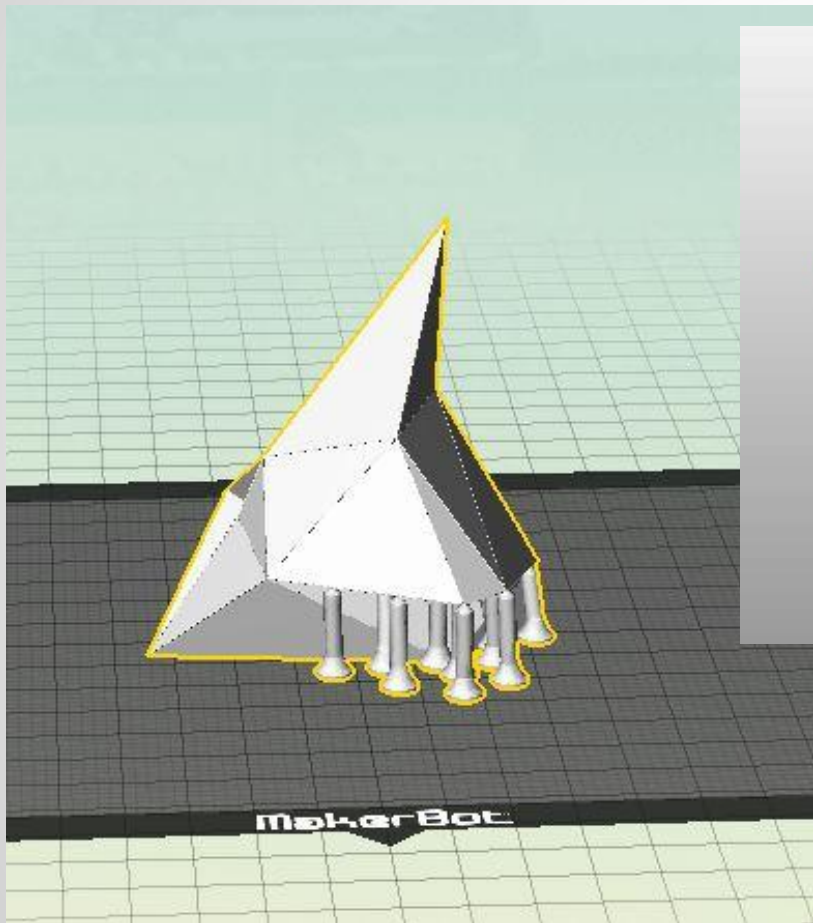

Complex Models



Workshops and Tours



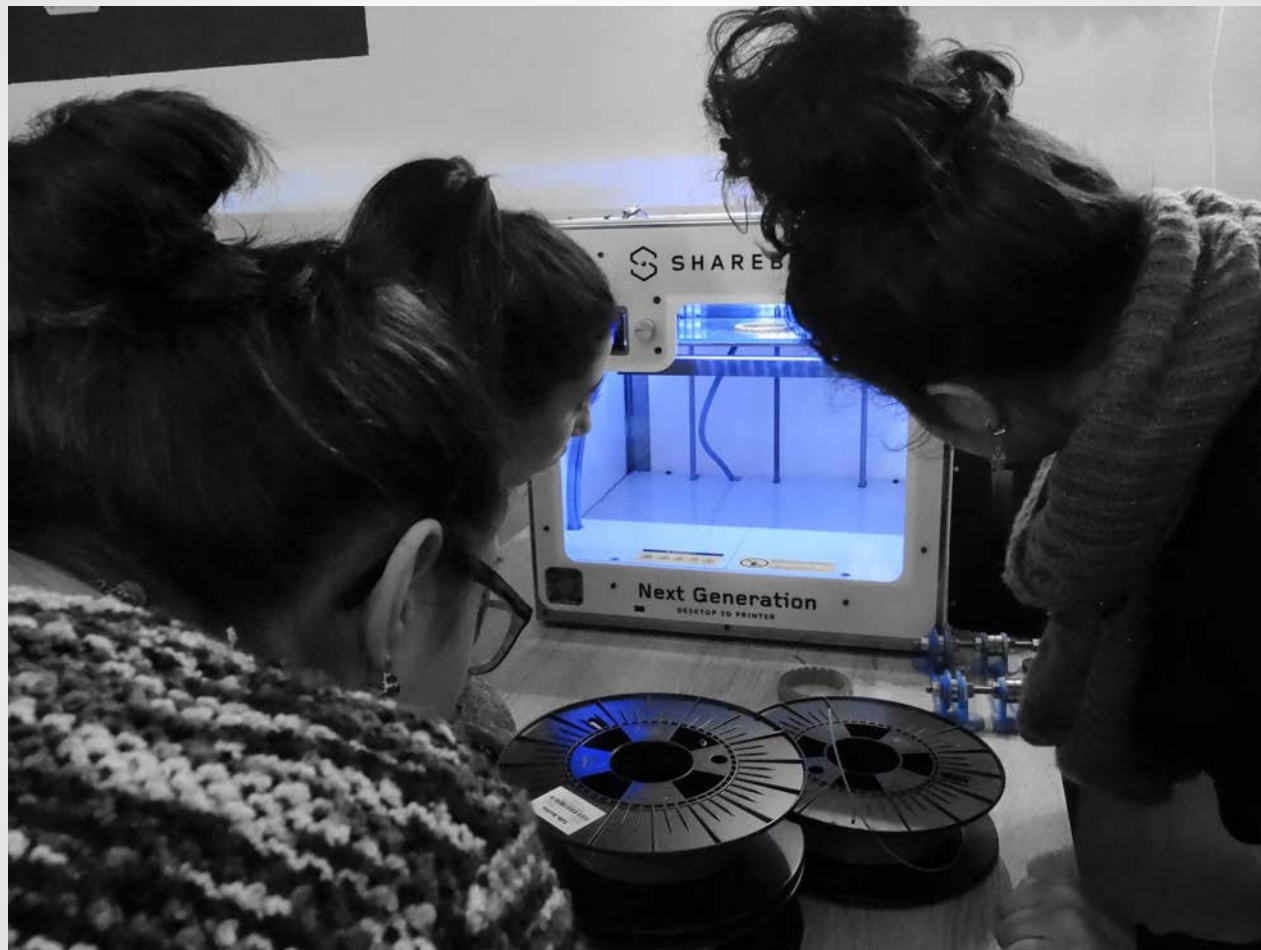



Events and Demos







Accessible Prosthetics - eNable

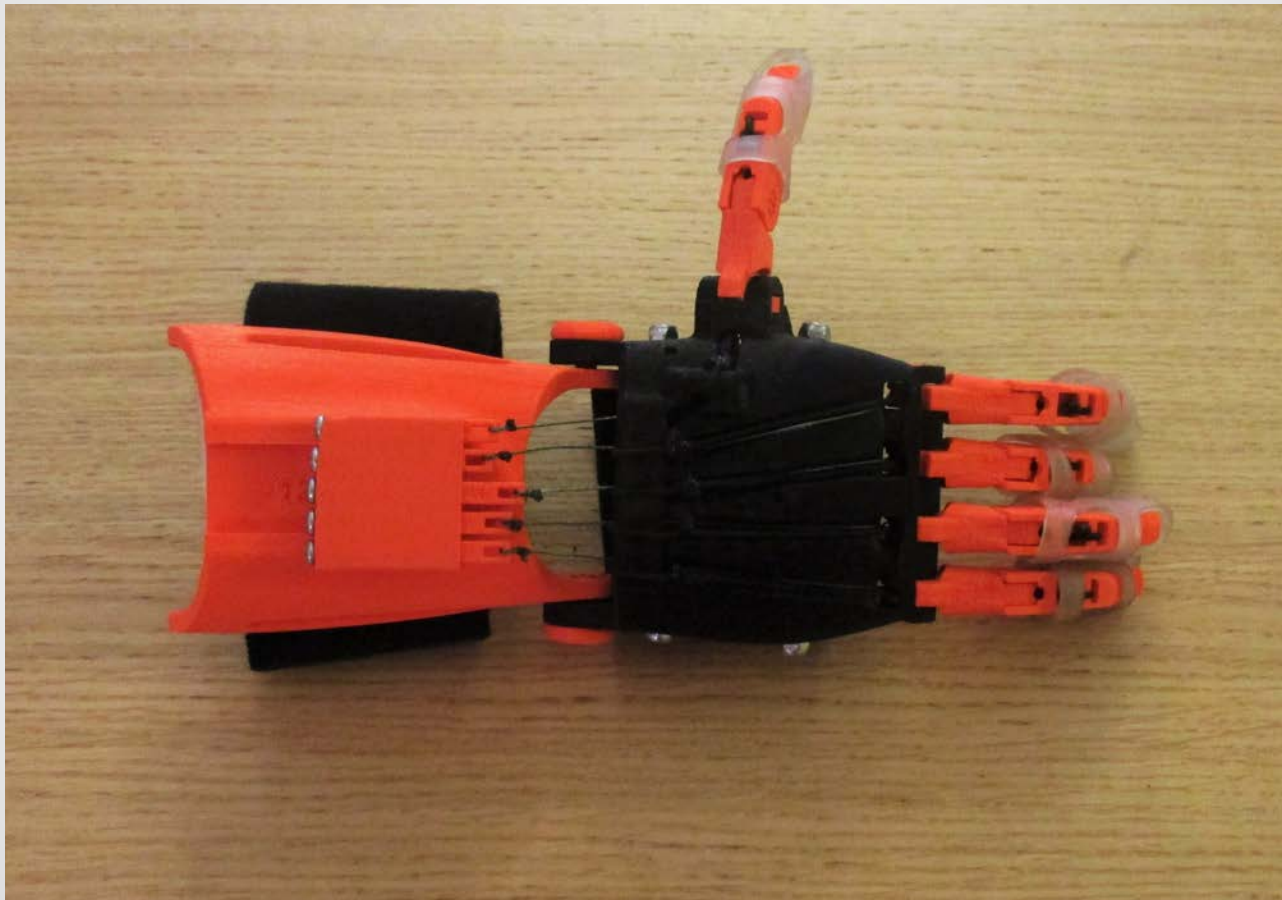



Dimension Alley

Medical Models from CT Scans





Geographically accurate terrain models





Nature printed

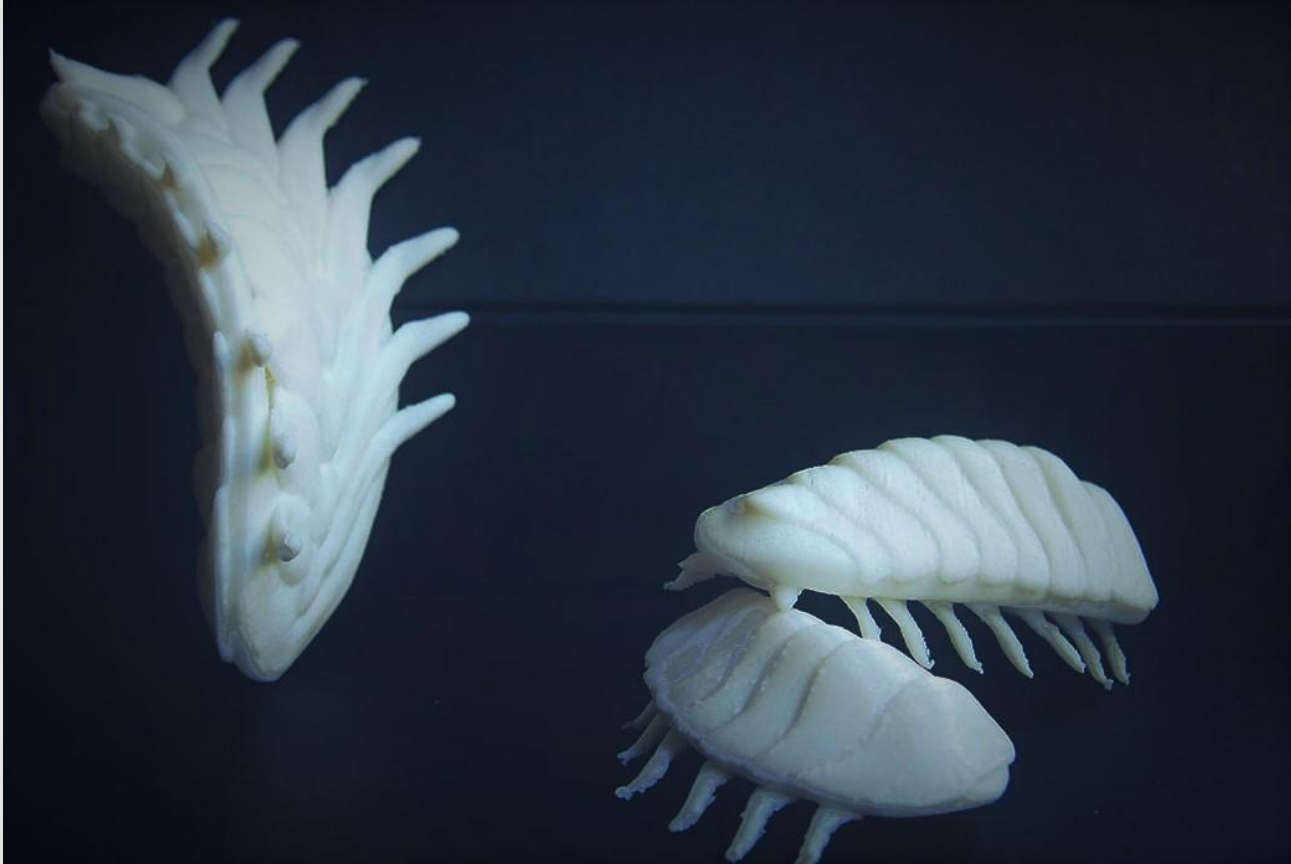



Art objects

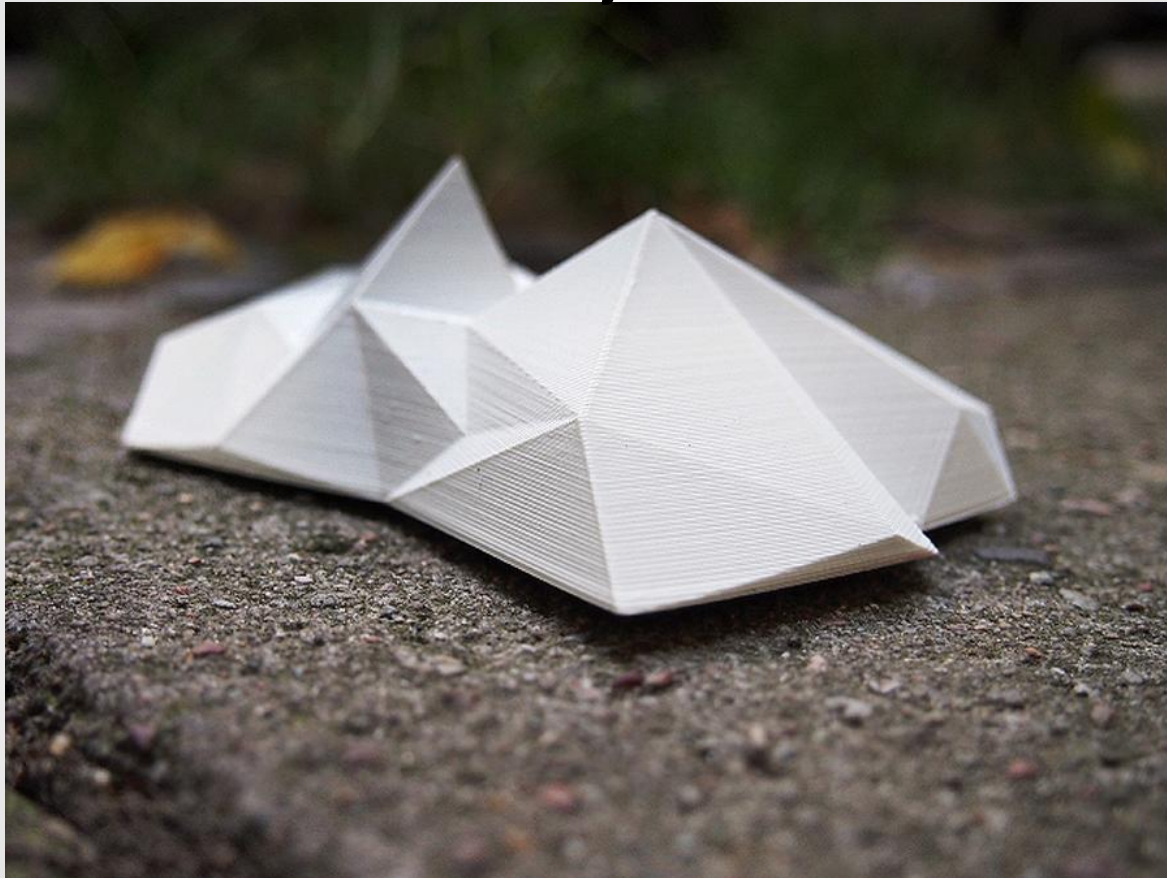



Dimension Alley



3D Art



Team events 3D Style





Marketing goods



3D Logos





Corporate Style

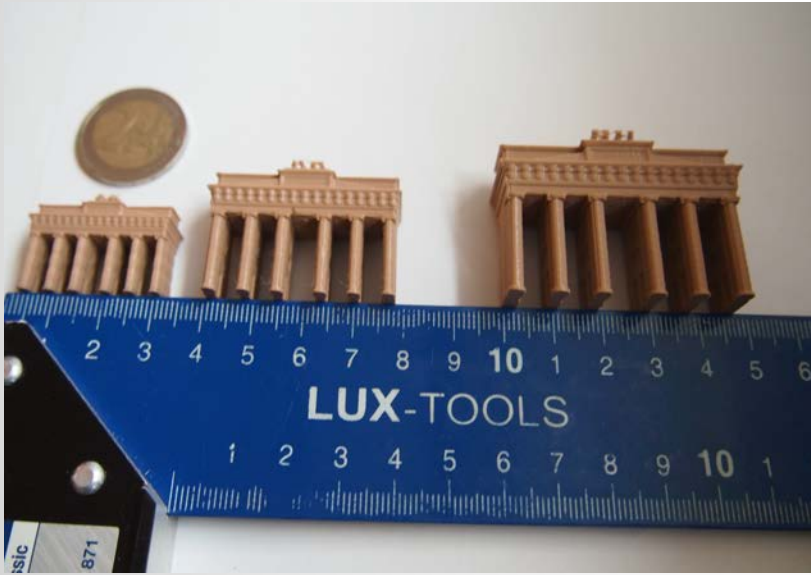



Jewellery





Dimension Alley

Jewellery





Concept models





Dimension Alley

Cast metal jewellery from 3D printed lost forms





Figure sculpting





Scan to figure





Finishing

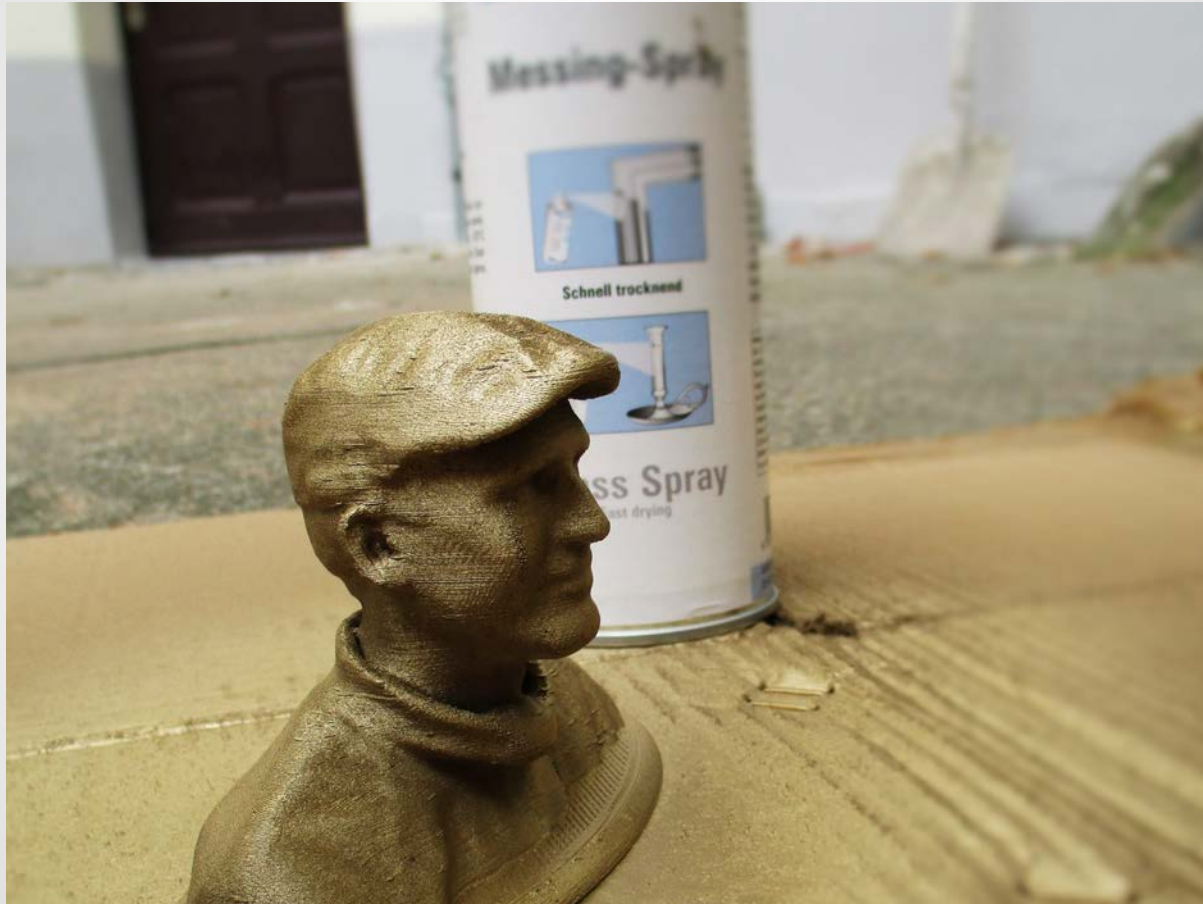



Finishing





As part of a project





As part of a project





Metal printing

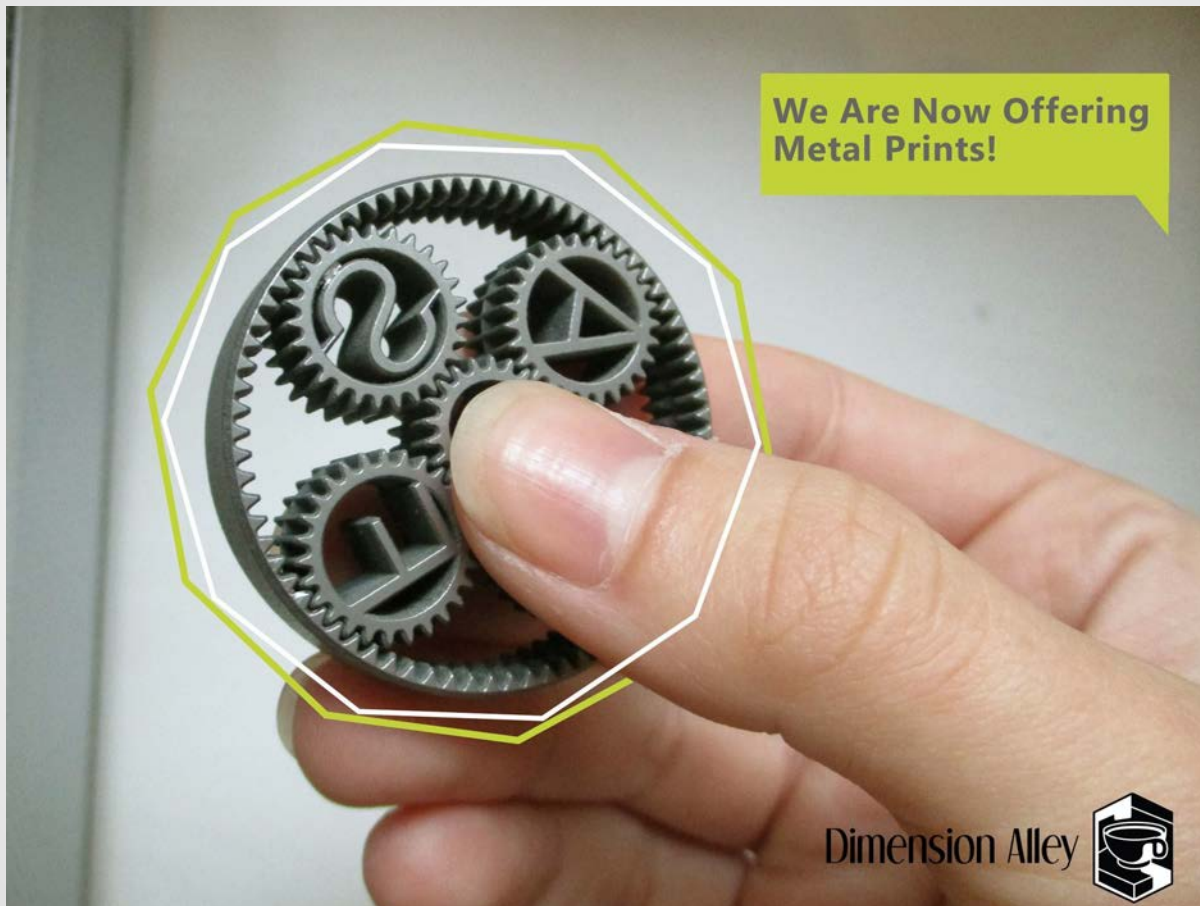

**We Are Now Offering
Metal Prints!**



Dimension Alley

Fashion tech





Fashion tech



ELEKTROCOUTURE



Dimension Alley

Fashion tech



ELEKTROCOUTURE



Dimension Alley

Fashion tech



ELEKTROCOUTURE



3D Printer Sales Filaments Spare parts

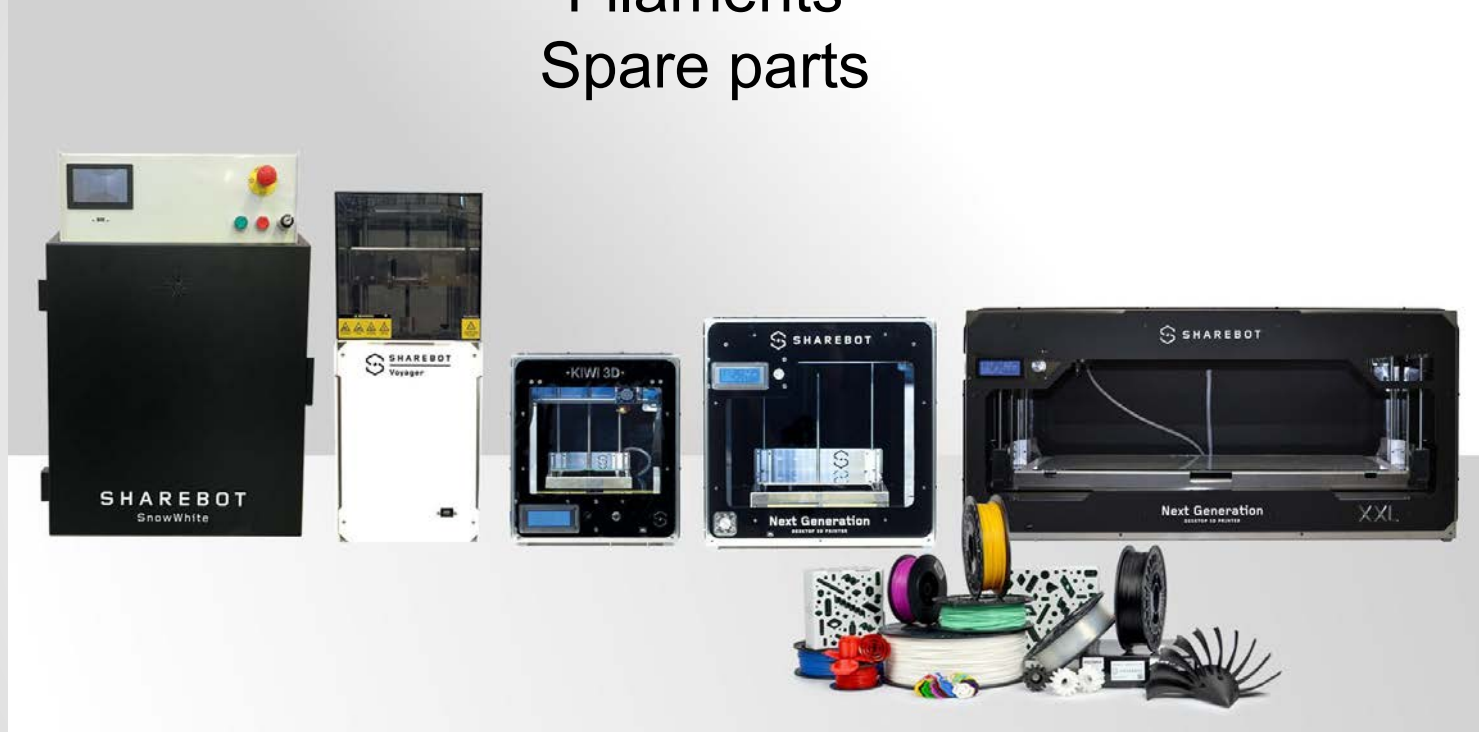



Filament

